



## LBLINE LIGHT BAR FIXTURE

The LBLine Lightbar is an RGBW LED light bar designed for Direct view illumination for both interior and exterior applications. Our fixtures have integrated power supplies & DMX decoders. Select from 12, 24 & 45 inch fixtures.

### PRODUCT HIGHLIGHTS

- **BINNING:** ± 50K
- **CRI:** 90
- **IP RATING:** IP66
- **STARTER CABLE:** 6, 19 & 49FT
- **EXPECTED LIFETIME:** L70 > 50,000 hours
- **OPERATING TEMP:** - 40 ° F to 122 ° F
- **RATING:** ETL
- **HOUSING:** Aluminum
- **VOLTAGE:** 120/277, 24v
- **WARRANTY:** 5 Years
- **DIMMABLE:** 0-10V, Triac, and Custom
- **BAA** available, consult factory

### AVAILABLE COLORS

- TW 2700-6000K
- RGBW
- Custom
- Extra Warm White 1800K
- Ultra Warm White 2200K
- Extra Warm White 2700K
- Warm White 3000K
- Cool White 3500K
- Natural White 4000K
- Custom



FLAT

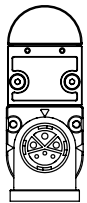

DOMED

### CHARACTERISTICS

Power		Lumen	Dimming
White	3.5 w/ft	221 lm/ft	0-10V
RGBW	7.0 w/ft	198 lm/ft	DMX

Notes:  
Lumen calculated at 2700K. Max Run calculated with 4 ft fixtures

Max run length see page 3

### ORDERING CHART

Example: LBLLine-4-18-PG-24-D1

Model		Length		Color				Finish	Voltage		Control	
LBLLine-F	Flat	1	12 in	18	1800k	RGBW-27	RGBW 27K	PG Gray	24	24v	D1	0-10V
LBLLine-D	Domed	2	24 in	27	2700k	RGBW-30	RGBW 30k		U	120/277V	D2	ELV/ Triac
		4	48 in	30	3000k	RGBW-40	RGBW 40k				D3	DMX
				35	3500k						CU	Custom
				40	4000k							
				65	6500k							
				CU	Custom							

**LBDirect DIMENSIONS & MOUNTING**

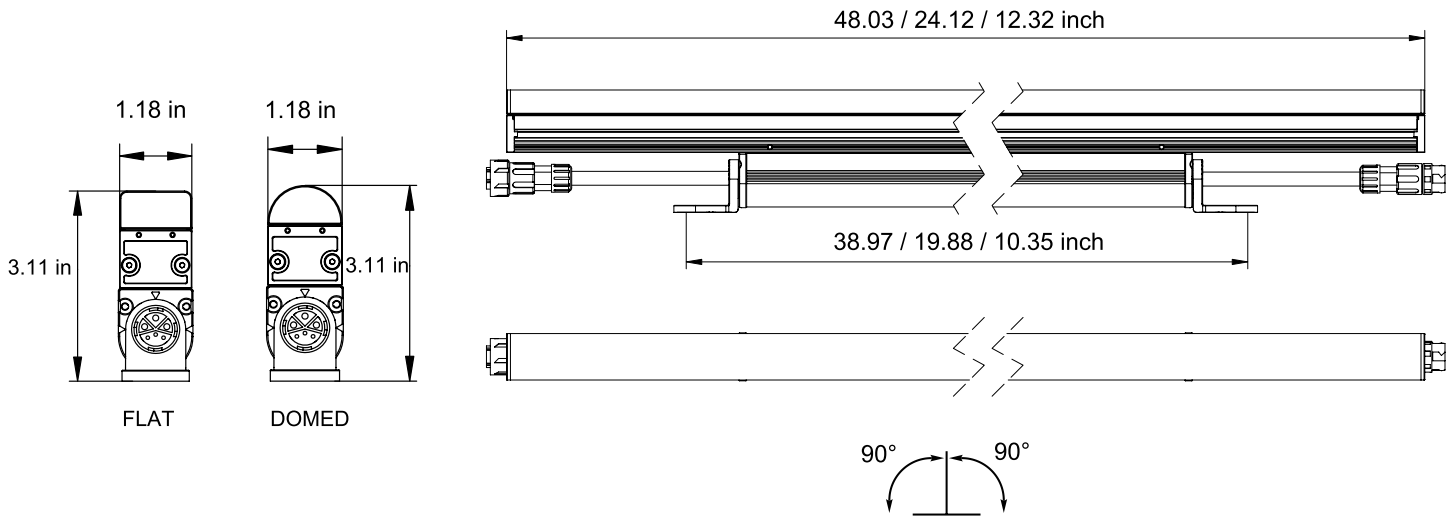

**Starter Cable**

Function: Power and Data Combined Lead-in  
**ITEM:** LBLLine-Start**LENGTH**

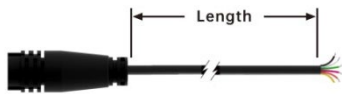

**LENGTH:** 6', 19', 49'

**Jumper Cable**

Function: Jumper  
**ITEM:** LBLLine-JM**PLENGTH**

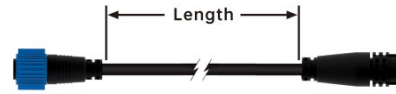

**LENGTH:** 1', 6', 1'

**TEE Cable**

Function: Power and Signal Combined T-joint  
**ITEM:** LBLLine-Tee



**End Cap**

Function: DMX Terminator  
**ITEM:** LBLLine-EndCap



**LBLINE CORD & FIXTURE DATA**

The core in the power and data cable are colored according to the following table:

Cable	Function	Core(US)	Core(EU)	Wire Size
Power lead in/ Power extension Cable	L (live)	Black	Brown	16AWG
	N (Neutral)	White	Blue	16AWG
	GND (Earth)	Green	Yellow/Green	16AWG
Data lead in	DMX+	Purple	Purple	22AWG
	DMX-	Gray	Gray	22AWG
	DMX GND	Yellow	Yellow	22AWG
Power and Data lead in/ Power data extension cable	L (live)	Black	Brown	16AWG
	N (Neutral)	White	Blue	16AWG
	GND (Earth)	Green	Yellow/Green	16AWG
	DMX+	Purple	Purple	22AWG
	DMX-	Gray	Gray	22AWG
	DMX GND	Yellow	Yellow	22AWG

The maximum number of connected fixtures in a daisy chain (Power):

Mode No	Voltage	Power connection (MAX)	Voltage	Power connection (MAX)	Signal Connection (RGBW: 40CH/4ft)
48 inch (RGBW)	24V DC	5 PCS	100~277 V AC	17 PCS(100~120V) 39 PCS(220~277V)	12 PCS
24 inch (RGBW)	24V DC	10 PCS	100~277 V AC	35 PCS(100~120V) 78 PCS(220~277V)	24 PCS
12 inch (RGBW)	24V DC	20 PCS	100~277 V AC	71 PCS(100~120V) 157 PCS(220~277V)	42 PCS
48 inch (mono white)	24V DC	5 PCS	100~277 V AC	17 PCS(100~120V) 39 PCS(220~277V)	-
24 inch (mono white)	24V DC	10 PCS	100~277 V AC	35 PCS(100~120V) 78 PCS(220~277V)	-
12 inch (mono white)	24V DC	20 PCS	100~277 V AC	71 PCS(100~120V) 157 PCS(220~277V)	-

Remark: The above values and number are only typical values. Actual number may vary due to the cable lengths and signal source.

**LBDIRECT ACCESSORIES**

---

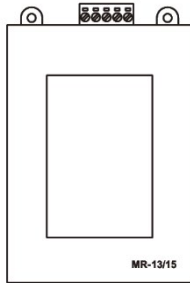

**Item:** MR-WT25  
**Brand:** MR Technology  
**Function:** DMX Address Writer and Tester  
**Description:** A portable, handheld device supporting DMX512 and RDM protocols, allowing for DMX channel programming, testing, and control with a USB Type-C power supply.

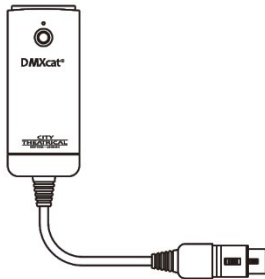

**Item:** DMXcat™  
**Brand:** City Theatrical  
**Function:** RDM Address Writer and Tester  
**Description:** A compact, battery-powered tool for DMX and RDM control via Bluetooth, supporting DMX testing, RDM monitoring, and DIP switch configuration through a smartphone app.



**Item:** DXC-RGB-I-WI  
**Brand:** Nicolaudie, Stick-DE3  
**Function:** DMX Controller  
**Description:** The Stick-DE3 is a compact DMX interface with 1024 DMX channels, offering scene storage and playback.. It supports real-time clock, calender with Sunrise/Sunset triggering.



## LEDSCAPE OUTDOOR POWER SUPPLY

The LEDscape Series of Constant Voltage Class 2 LED Drivers from offers both cETLus style enclosures. The enclosure has a built-in junction box on both the input and output. These drivers are IP68 and are suitable for all locations. With universal input voltage ranging from 120 to 277VAC, this series of drivers are designed for commercial, industrial and residential applications. Our 5in1 smooth flicker-free linear dimming down to 1% and a wide variety of compatible dimmers, including 0-10V, Magnetic and Low voltage.

### PRODUCT HIGHLIGHTS

- **INPUT VOLTAGE:** 120/277 V
- **OUTPUT VOLTAGE:** Variable 18-25V
- **INPUT FREQUENCY:** 50/60 HZ
- **OPERATING TEMP:** -13°F – 104°F
- **DEGREE OF PROTECTION (IP):** IP68
- **DIMMABLE:** to 1%
- **CLASS 2:** All sizes
- **LOAD REQUIREMENTS:** 10%

Note: If using outdoor, verify contractor use included water and moisture tight enclosure. Not direct burial rated.

### POWER AND CONNECTION DIAGRAM

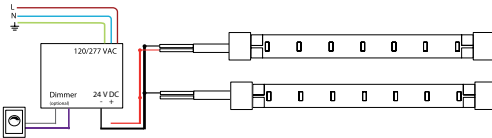

**POWER SUPPLY** = Product Wattage X Length

24 Nominal supply voltage of LEDscape in Volt  
Recommended MAC output of power supply 80%

To calculate MAX run distance from Power Supply to LED  
reference power drop chart : [Here](#).

### CHARACTERISTICS

Power	Output Current	Efficiency	Power Factor	Dimensions
30W	1250mA	> 86%	>0.95	7.50" L X 3.62" W X 1.65"H
60W	2600mA	> 86%	>0.95	7.50" L X 3.62" W X 1.65"H
96W	4800mA	> 86%	>0.95	8.50" L X 3.66" W X 1.65"H
120W	5000mA	> 86%	>0.93	10.15" L X 4.85" W X 1.65"H
192W	8000mA	> 86%	>0.93	10.15" L X 4.85" W X 1.65"H
288W	8000mA	> 86%	>0.93	12.44" L X 4.85" W X 1.65" H
384W	16000mA	> 86%	>0.93	12.44" L X 4.85" W X 1.65" H

### ORDERING CHART

**NOTE:** View additional options [here](#).

**Ordering Example:** PS-24-0-D3-60L-U

Series		Output Voltage		Environment		Dimming		Wattage		Voltage Input	
PS	Power supply	24	24V	0	Outdoor/Indoor	ND	Non Dimming	30L	10-30W	U	120/277V
						D3	5 in 1 Dimming	60L	31-60W		
								96L	61-96W		
								120L	97-120W		
								192L	121-192W		
								288L	193-288W		
								384L	289-384W		
								CUL	Custom Output		

**DISCLAIMER:** The information on these pages are as accurate as possible, however LEDscape or any reseller of LEDscape cannot be held liable for any damages resulting from errors or outdated information. LEDscape reserves the right to modify the information without informing the customers. Check for the latest version on the Internet, the most up to date information will be published on [www.ledscape.com](http://www.ledscape.com). Qualified and Licensed Electrical Contractor must install the product. This product should not be used in applications, devices or systems where incorrect operation of the product may result in personal injury (includes emergency lighting) without written permission from LEDscape. If nevertheless used in such applications, devices or systems LEDscape cannot be held liable for any resulting injury.



## LEDSCAPE DMX POWER SUPPLIES

The LEDscape Series of Constant Voltage Class 2 LED Drivers from offers both cETLus style enclosures. The enclosure has a built-in junction box on both the input and output. These drivers are IP68 and are suitable for all locations. With universal input voltage ranging from 120 to 277VAC, this series of drivers are designed for commercial, industrial and residential applications. Our DMX RGBW smooth flicker-free linear dimming down to 1% with any DMX controller. RDM Protocol for ease of on-site programming.

### PRODUCT HIGHLIGHTS

- **INPUT VOLTAGE:** 120/277 V
- **OUTPUT VOLTAGE:** Variable 18-25V
- **INPUT FREQUENCY:** 50/60 HZ
- **OPERATING TEMP:** -13°F – 104°F
- **PROTOCOL:** DMX512 RDM
- **DEGREE OF PROTECTION (IP):** IP68
- **DIMMABLE:** to 1%
- **CLASS 2:** All sizes
- **LOAD REQUIREMENTS:** 10%

Note: If using outdoor, verify contractor use included water and moisture tight enclosure. Not direct burial rated.

### POWER AND CONNECTION DIAGRAM

$$\text{POWER SUPPLY} = \text{Product Wattage} \times \text{Length} \times 120 \times \left[ \frac{U \text{ Supply}}{24} \right]$$

**OPTIONS:**

U Set supply voltage of the power supply in Volt  
24 Nominal supply voltage of LEDscape in Volt  
Recommended MAC output of power supply 80%

To calculate MAX run distance from Power Supply to LED reference power drop chart : [Here](#).

Note: If using outdoor, verify contractor use included water and moisture tight enclosure. Not direct burial rated.

### CHARACTERISTICS

Power	Output Current	Efficiency	Power Factor	Dimensions
120W	4100mA	> 95%	>0.95	9.50" L X 3.62" W X 1.65" H
300W	8200mA	> 95%	>0.95	12.5" L X 10.25" W X 1.81" H

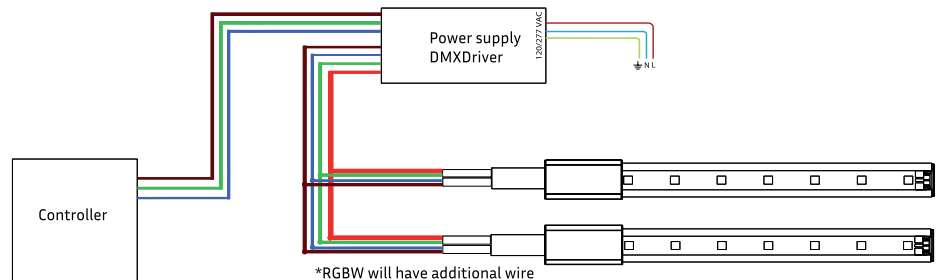

### ORDERING CHART

**NOTE:** View additional options [here](#).

**Ordering Example:** PS-24-0-DMX-120-U

Series		Output Voltage		Environment		Dimming		Wattage		Voltage Input	
PS	Power Supply	24	24V	0	Outdoor/Indoor	DMX	DMX 512	120	60-120W	U	120/277V
								300	121-300W		
								CU	Custom Output		

**Notes:**

Power Supplies should still be in outdoor enclosure if direct buried application. LEDscape Lighting does NOT conduct start-up and/or programming. Advise to hire DMX professional if needed.

**DISCLAIMER:** The information on these pages are as accurate as possible, however LEDscape or any reseller of LEDscape cannot be held liable for any damages resulting from errors or outdated information. LEDscape reserves the right to modify the information without informing the customers. Check for the latest version on the Internet, the most up to date information will be published on [www.ledscape.com](http://www.ledscape.com). Qualified and Licensed Electrical Contractor must install the product. This product should not be used in applications, devices or systems where incorrect operation of the product may result in personal injury (includes emergency lighting) without written permission from LEDscape. If nevertheless used in such applications, devices or systems LEDscape cannot be held liable for any resulting injury.



## LEDSCAPE CCT POWER SUPPLIES

The LEDscape Series of Constant Voltage Class 2 LED Drivers from offers both cETLus style enclosures. The enclosure has a built-in junction box on both the input and output. These drivers are IP68 and are suitable for all locations. With universal input voltage ranging from 120 to 277VAC, this series of drivers are designed for commercial, industrial and residential applications. Our smooth flicker-free linear dimming down to 1% with most Dimmers. Pick from Dim to Warm OR CCT Tunable.

### PRODUCT HIGHLIGHTS

- **INPUT VOLTAGE:** 120/277 V
- **OUTPUT VOLTAGE:** Variable 18-25V
- **INPUT FREQUENCY:** 50/60 HZ
- **OPERATING TEMP:** -13°F – 104°F
- **CCT TUNABLE:** Triac, 0-10V
- **WARM DIM:** Triac, 0-10V
- **DEGREE OF PROTECTION (IP):** IP68
- **DIMMABLE:** to 1%
- **CLASS 2:** All sizes
- **LOAD REQUIREMENTS:** 10%

Note: If using outdoor, verify contractor use included water and moisture tight enclosure. Not direct burial rated.

### POWER AND CONNECTION DIAGRAM

$$\text{POWER SUPPLY} = \text{Product Wattage} \times \text{Length} \times 120 \times \left[ \frac{U \text{ Supply}}{24} \right]$$

**OPTIONS:**

U Set supply voltage of the power supply in Volt  
24 Nominal supply voltage of LEDscape in Volt  
Recommended MAC output of power supply 80%

To calculate MAX run distance from Power Supply to LED reference power drop chart : [Here](#).

Note: If using outdoor, verify contractor use included water and moisture tight enclosure. Not direct burial rated.

### CHARACTERISTICS

Power	Output Current	Efficiency	Power Factor	Dimensions
30W	1250mA	> 96%	>0.95	7.50" L X 54.05" W X 1.65"H
96W	4800mA	> 96%	>0.95	8.50" L X 4.05" W X 1.65"H
150W	6100mA	> 86%	>0.95	12.15" L X 4.85" W X 1.65"H

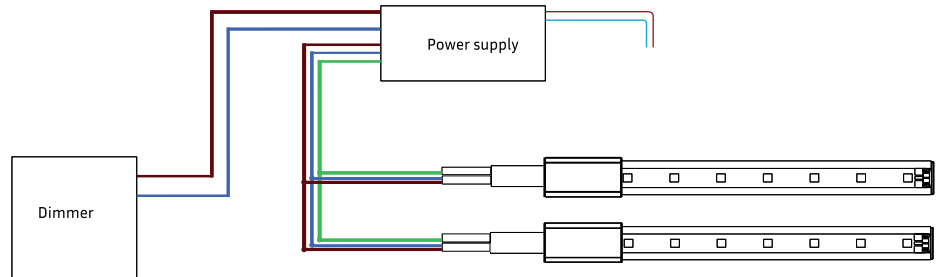

Illustration only, setup may differ. consult install instructions

### ORDERING CHART

**NOTE:** View additional options [here](#).

**Ordering Example:** PS-24-0-CCT-60-U

Series		Output Voltage		Environment		Dimming		Wattage		Voltage Input	
PS	Power Supply	24	24V	0	Outdoor/Indoor	CCT	Tunable White & Warm Dimming	30	30W	U	120/277V
								96	31-96W		
								150	97-150W		
								CU	Custom Output		

**DISCLAIMER:** The information on these pages are as accurate as possible, however LEDscape or any reseller of LEDscape cannot be held liable for any damages resulting from errors or outdated information. LEDscape reserves the right to modify the information without informing the customers. Check for the latest version on the Internet, the most up to date information will be published on [www.ledscape.com](http://www.ledscape.com). Qualified and Licensed Electrical Contractor must install the product. This product should not be used in applications, devices or systems where incorrect operation of the product may result in personal injury (includes emergency lighting) without written permission from LEDscape. If nevertheless used in such applications, devices or systems LEDscape cannot be held liable for any resulting injury.